





SMT POWER INDUCTORS

Power Beads - PA0511HL



-  **Current Rating:** Over 70Apk
-  **Inductance Range:** 85nH to 220nH
-  **Height:** 4.96 mm Max
-  **Footprint:** 10.2mm x 7.0 mm
-  **Halogen Free:** < 900ppm Cl, < 900ppm Br

Electrical Specifications @ 25°C — Operating Temperature -40°C to +130°C⁷

Part Number	Inductance @0A _{DC} (nH ±20%)	Inductance @I _{rated} (nH TYP)	I _{rated} ¹ (A _{DC})	DCR ² (mΩ)	Saturation Current ³ (TYP)		Heating ⁴ Current (A TYP)
					25°C	100°C	
PA0511NL and PA1211NL - 10.2mm x 7.0mm x 4.96mm Max							
PA0511.850HLT	85	85	31	0.39 ±7.7%	70+	70	31
PA0511.900HLT	100	100	31		70	65	
PA0511.101HLT	120	120	31		52	42	
PA0511.151HLT	155	150	31		40	36	
PA0511.221HLT	220	176	25		33	25	

NOTES:

- The rated current as listed is either the saturation current or the heating current depending on which value is lower.
- The nominal DCR tolerance is by design. The nominal DCR is measured from point a to point b, as shown below on the mechanical drawing.
- The saturation current is the typical current which causes the inductance to drop by 20% at the stated ambient temperatures (25°C and 100°C). This current is determined by placing the component in the specified ambient environment and applying a short duration pulse current (to eliminate self-heating effects) to the component.
- The heating current is the DC current which causes the part temperature to increase by approximately 40°C. This current is determined by soldering the component on a typical application PCB, and then applying the current to the device for 30 minutes without any forced air cooling.
- In high volt*time applications, additional heating in the component can occur due to core losses in the inductor which may necessitate derating the current in order to limit the temperature rise of the component. To determine the approximate total losses (or temperature rise) for a given application, the coreloss and temperature rise curves can be used.
- Pulse complies to industry standard tape and reel specification EIA481.
- The temperature of the component (ambient plus temperature rise) must be within the stated operating temperature range.

Mechanical

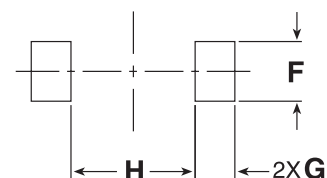
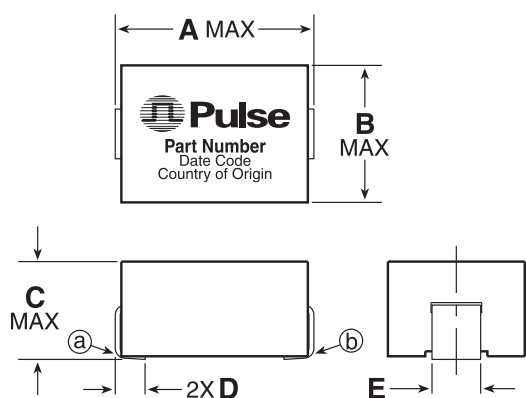

SUGGESTED PAD LAYOUT

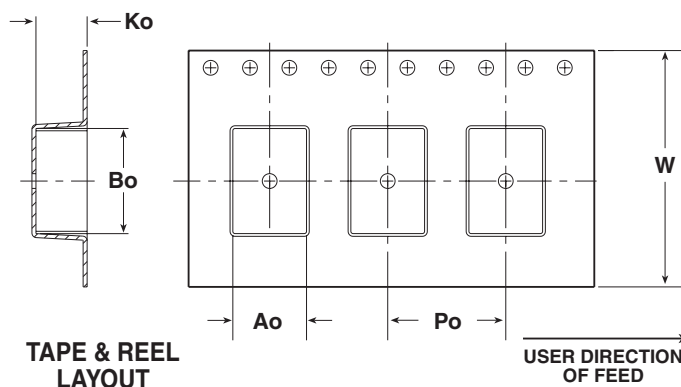

TAPE & REEL LAYOUT

Dimensions: $\frac{\text{Inches}}{\text{mm}}$
 Unless otherwise specified,
 all tolerances are $\pm \frac{0.10}{0.25}$

Schematic

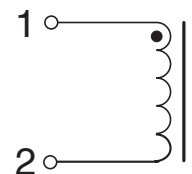

SMT POWER INDUCTORS

Power Beads - PA0511HL



Dimensions (inches/mm)

Part Number	Mechanical Dimensions							T&R Dimensions						Parts/Reel	Weight (grams)
	A (MAX)	B (MAX)	C (MAX)	D (NOM)	E (NOM)	F (NOM)	G (NOM)	H (NOM)	Ao	Bo	Ko	Po	W		
PA0511/PA1211	.400 10,20	.276 7,00	.195 4,96	.060 1,52	.098 2,49	.120 3,05	.080 2,03	.250 6,35	.295 7,49	.420 10,67	.205 5,21	.472 12,00	.945 24,00	1000	1.35

PA0511HL

Inductance vs Current

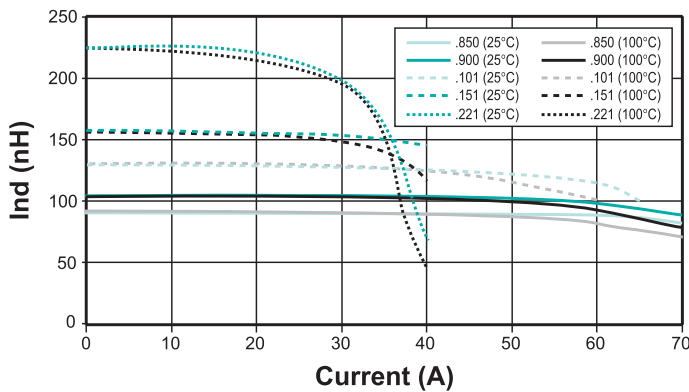

CoreLoss vs Flux Density

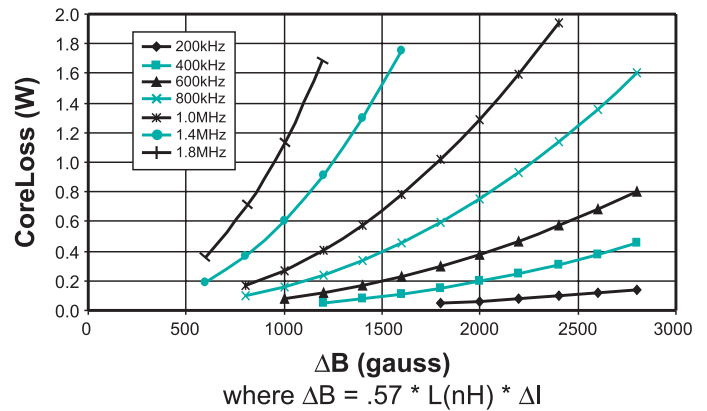

Temp Rise vs Power Dissipation

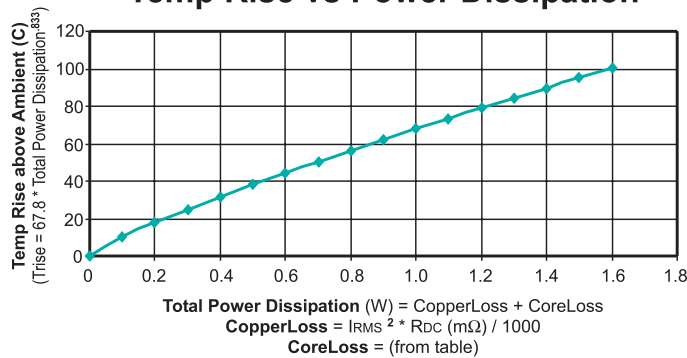

Pulse Worldwide Headquarters
12220 World Trade Dr.
San Diego, CA 92128
U.S.A.

Pulse Europe
Einsteinstrasse 1
D-71083 Herrenberg
Germany

Pulse China Headquarters
B402, Shenzhen Academy of
Aerospace Technology Bldg.
10th Kejian Rd.
High-Tech Zone
Nanshan District
Shenzhen, PR China 518057

Pulse North China
Room 1503
XinYin Building
No. 888 YiShan Rd.
Shanghai 200233
China

Pulse South Asia
135 Joo Seng Rd.
#03-02
PM Industrial Bldg.
Singapore 368363

Pulse North Asia
No. 26, Kao Ching Rd.
Yang Mei Chen
Taoyuan Hsien
Taiwan
R. O. C.

www.pulseeng.com
Tel: 858 674 8100
Fax: 858 674 8262

Tel: 49 7032 7806 0
Fax: 49 7032 7806 135

TEL: 86 755 33966678
FAX: 86 755 33966700

Tel: 86 21 54643211/2
Fax: 86 21 54643210

TEL: 65 6287 8998
FAX: 65 6280 0080

Tel: 886 3 4643715
Fax: 886 3 4641911

Performance warranty of products offered on this data sheet is limited to the parameters specified. Data is subject to change without notice. Other brand and product names mentioned herein may be trademarks or registered trademarks of their respective owners.
© Copyright, 2009. Pulse Engineering, Inc. All rights reserved.